



**ITEM #14421**

**10'x14' Veranda Gazebo – Gazebo Veranda**

**Instructions générales**









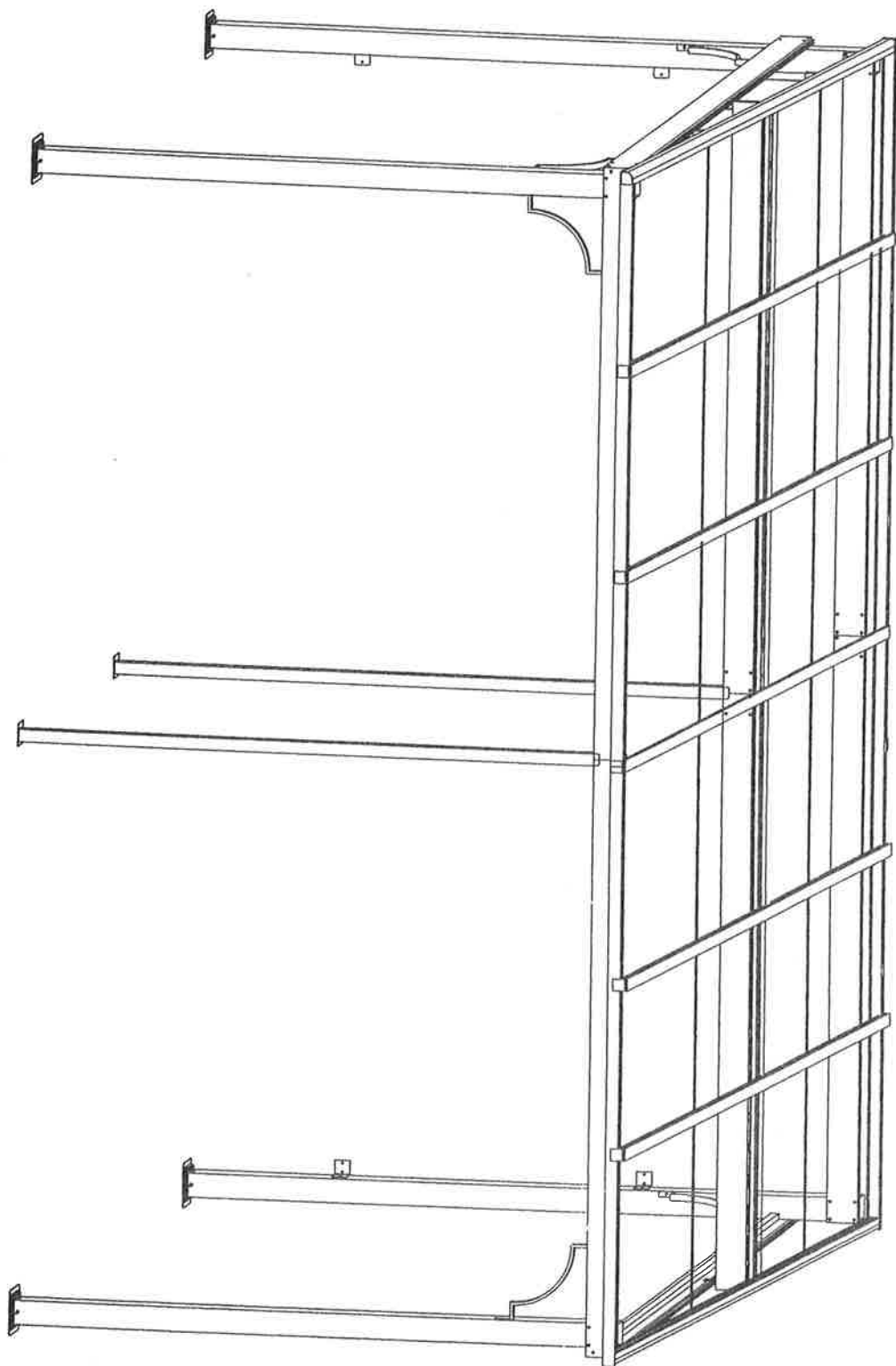





















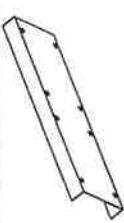







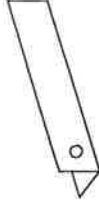





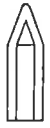

1. Avant de commencer l'assemblage, comptez et vérifiez la liste des pièces afin de s'assurer que toutes les pièces sont dans la boîte.
2. Cette structure devrait être montée sur un terrain plat
3. Conservez ces instructions pour référence future.
4. Ne pas serrer les vis jusqu'à ce que la structure soit entièrement assemblée.
5. Ne pas retourner au vendeur. Au cas où vous avez besoin de pièces ou de l'aide, appelez-nous du lundi au vendredi de 9 :00 à 16 :30 au (1-888) 288-3872 ou par courriel à [brenda@durahousewares.com](mailto:brenda@durahousewares.com)
6. S'il vous plaît, suivez les instructions étape par étape et vous n'aurez pas de problème de montage.
7. Dans les zones d'accumulation de neige lourde, il est recommandé d'enlever les panneaux du toit et les rideaux.
8. Des soins adéquats vous donneront plusieurs années d'utilisation de ce produit.
9. Si vous avez des pièces endommagées et que vous avez besoin de remplacement, s'il vous plaît envoyez des photos et preuve d'achat par courriel afin que nous puissions mieux vous servir.

**General instructions**

1. Before you start the assembly, count and check the parts list to make sure that all parts are in the box.
2. This structure should be mounted on flat even ground.
3. Keep this instructions sheet for future reference.
4. Do not tighten screws until structure is fully assembled.
5. Do not return to vendor. In case you need parts or help, call us Monday to Friday from 9:00 am to 4:30 pm at (1-888) 288-3872 or email us at [brenda@durahousewares.com](mailto:brenda@durahousewares.com)
6. Please follow step by step instructions and you will not have any assembly problem.
7. In areas of heavy snow accumulation, it is recommended to remove roof panels and curtains.
8. Proper care will give you years of usage of this product.
9. If you have damaged parts and you need replacement please send pictures and receipt by email, so we can serve you better.

VERANDA GAZEBO - FRAME  
GAZEBO VERANDA - STRUCTURE  
10' X 14'



A/2PC 	B/1PC 	C/1PC 	D/1PC 
E/1PC 	F/1PC 	G/1PC 	H1/1PC 
I1/1PC 	J/6PCS 	K/1PC 	H2/1PC 
I2/1PC 	N/6PCS 	O/6PCS 	L/1PC 
M/5PC 	R/6PCS 	S/6PCS 	P/1PC 
Q/1PC 	V/3PCS 	W/14PCS 	T/2PCS 
U/2PCS 	Z/4PCS 	L/2PCS 	X/15PCS 
Y/6PCS 			2/1PC 
3/4PCS 	4/8PCS 	5/1PC 	6/1PC 
7/4PCS 	8/8PCS 	9/15PCS 	7/12PCS 
10/8PCS 	11/32PCS 	12/155PCS 	8/1PC 
B2/1PC 	13/2PCS 	D1/1PC 	A2/1PC 
		D2/1PC 	B1/1PC 

Step:1  
Etape:1

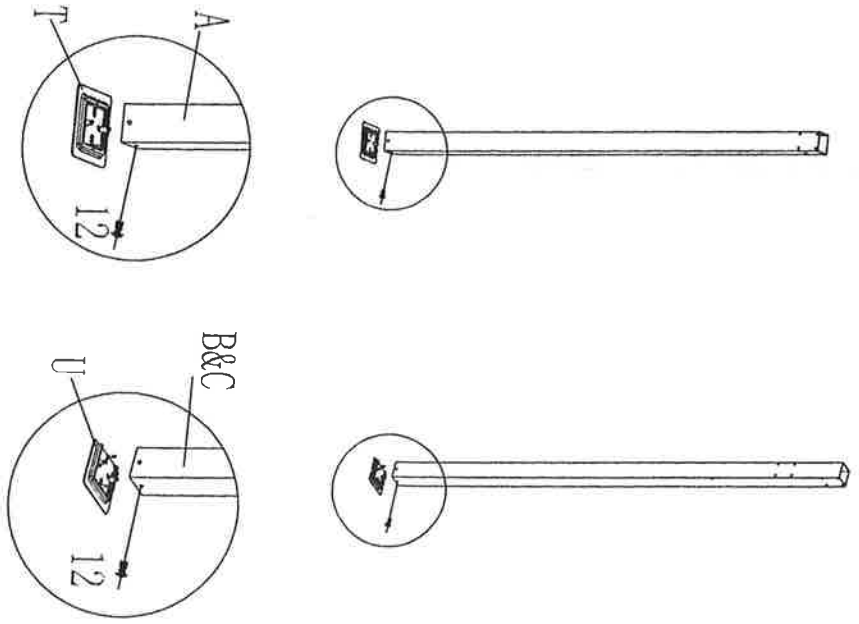

Step:2  
Etape:2

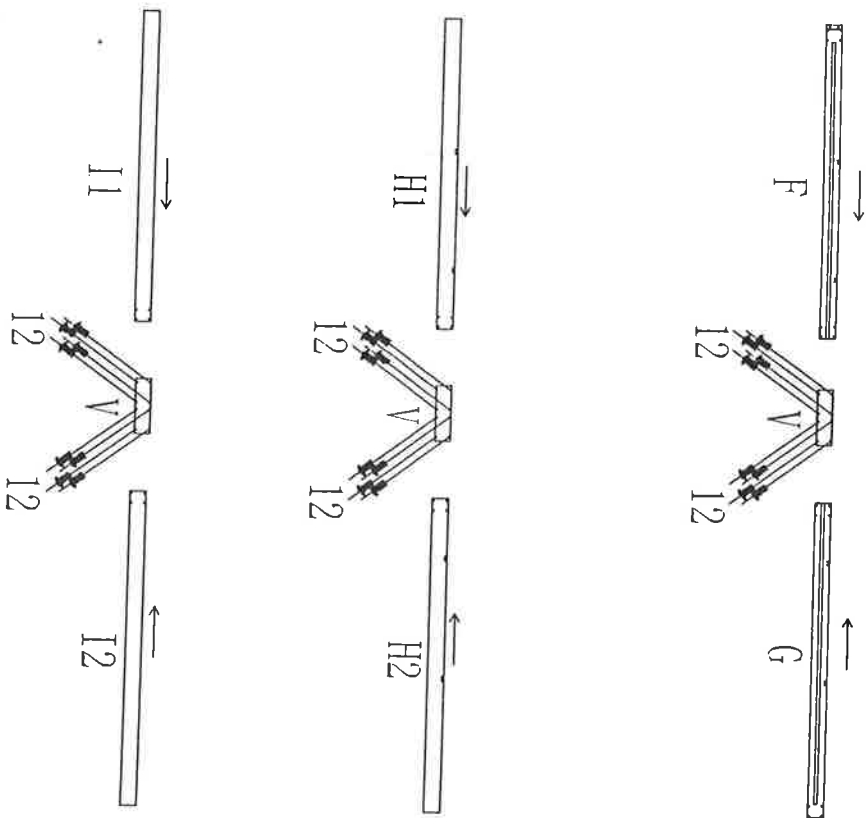

Step:3  
Etape:3

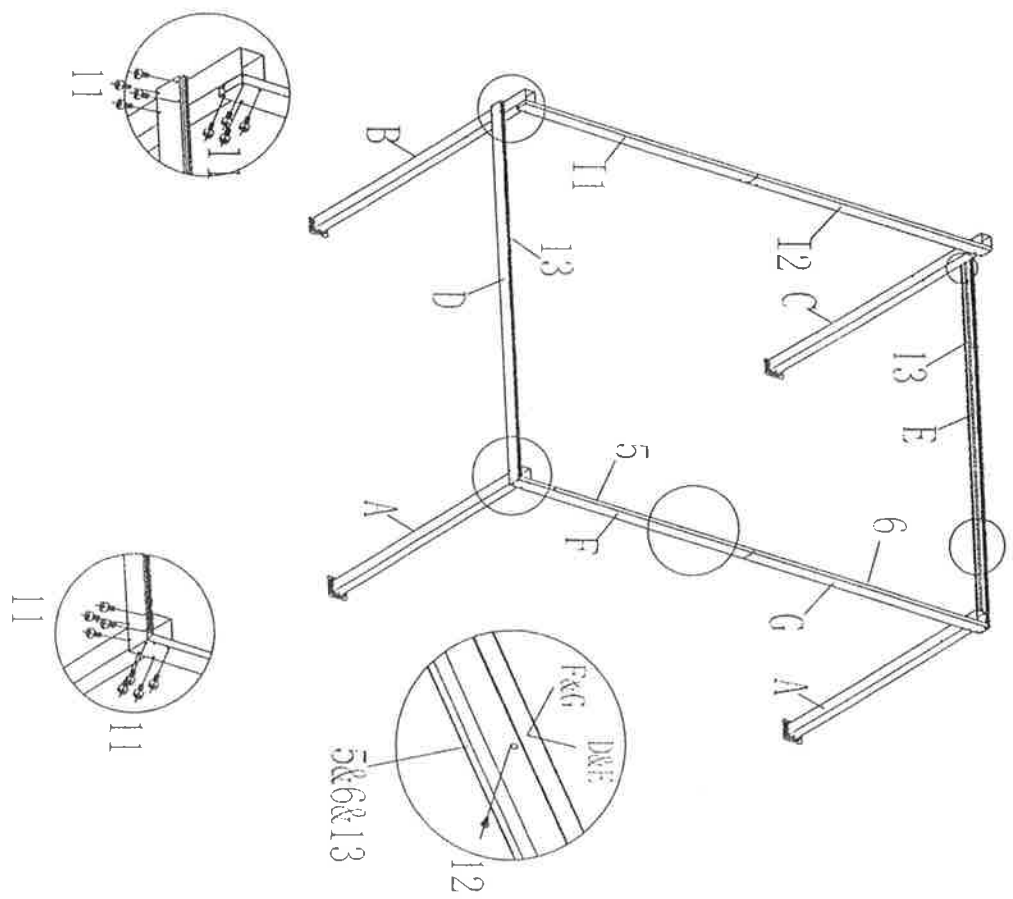

Step:4  
Etape:4

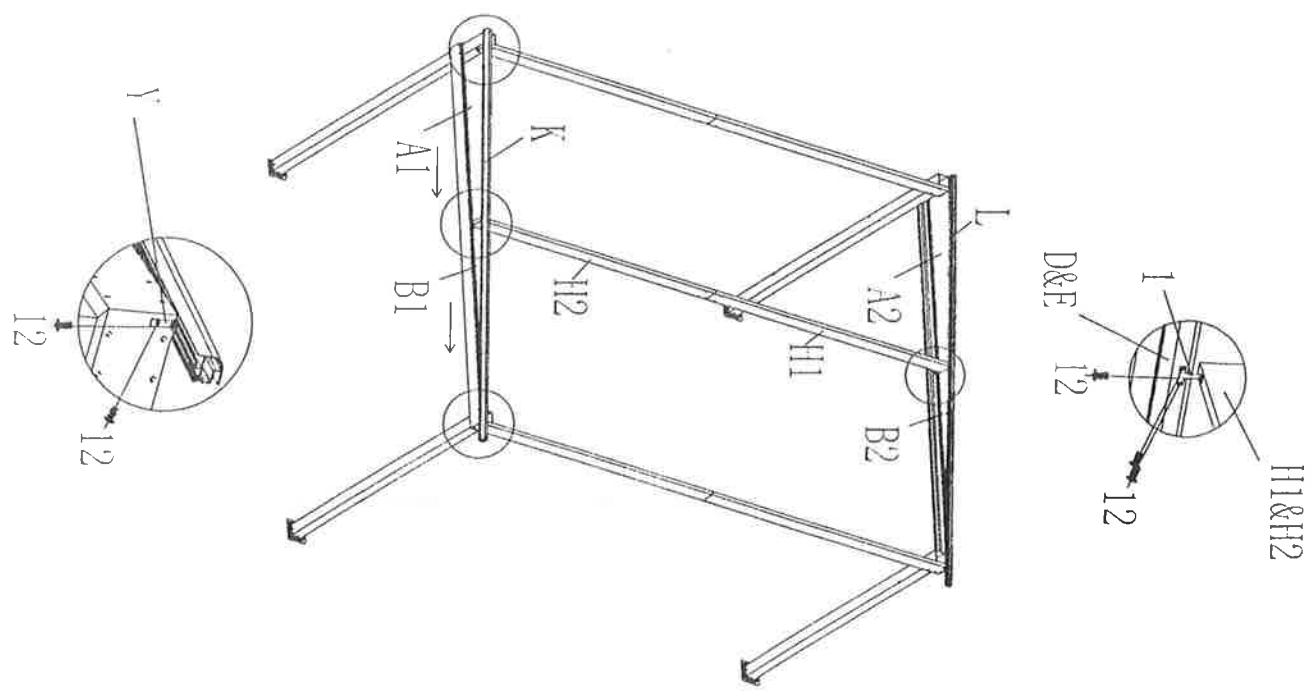

Step:5  
Etape:5

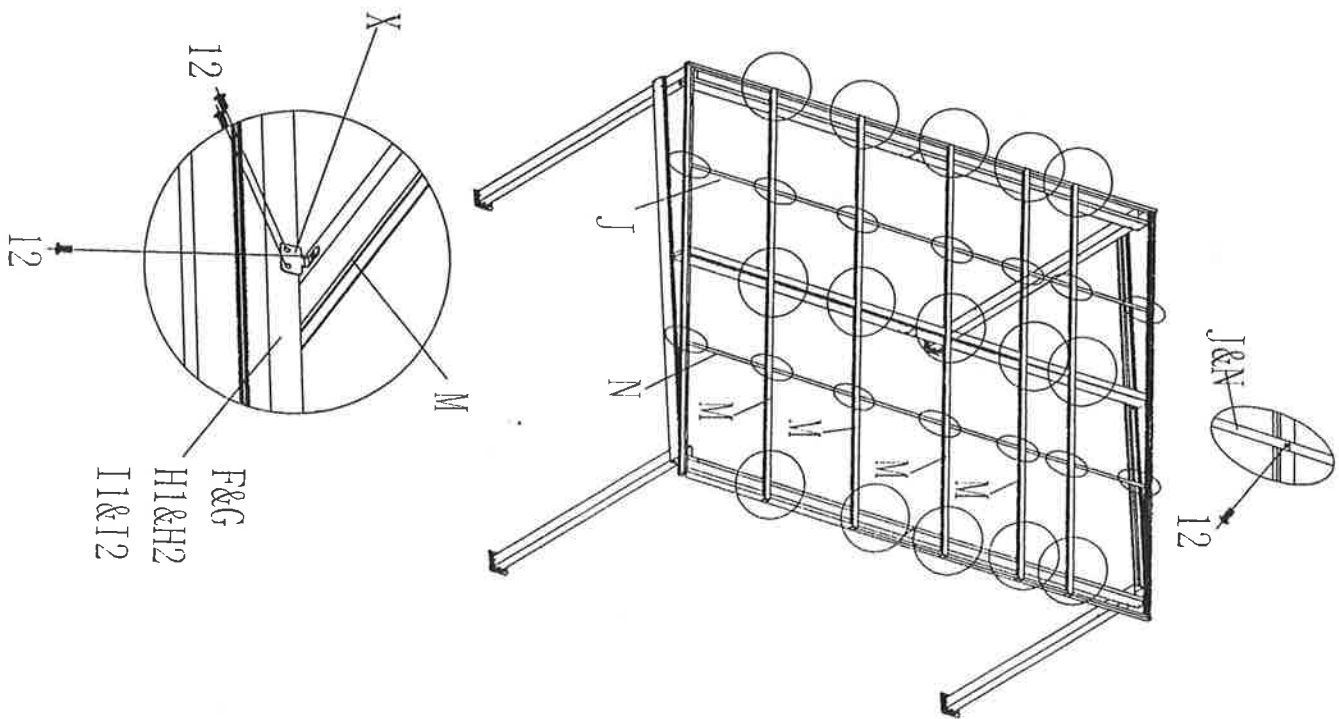

Step:6  
Etape:6

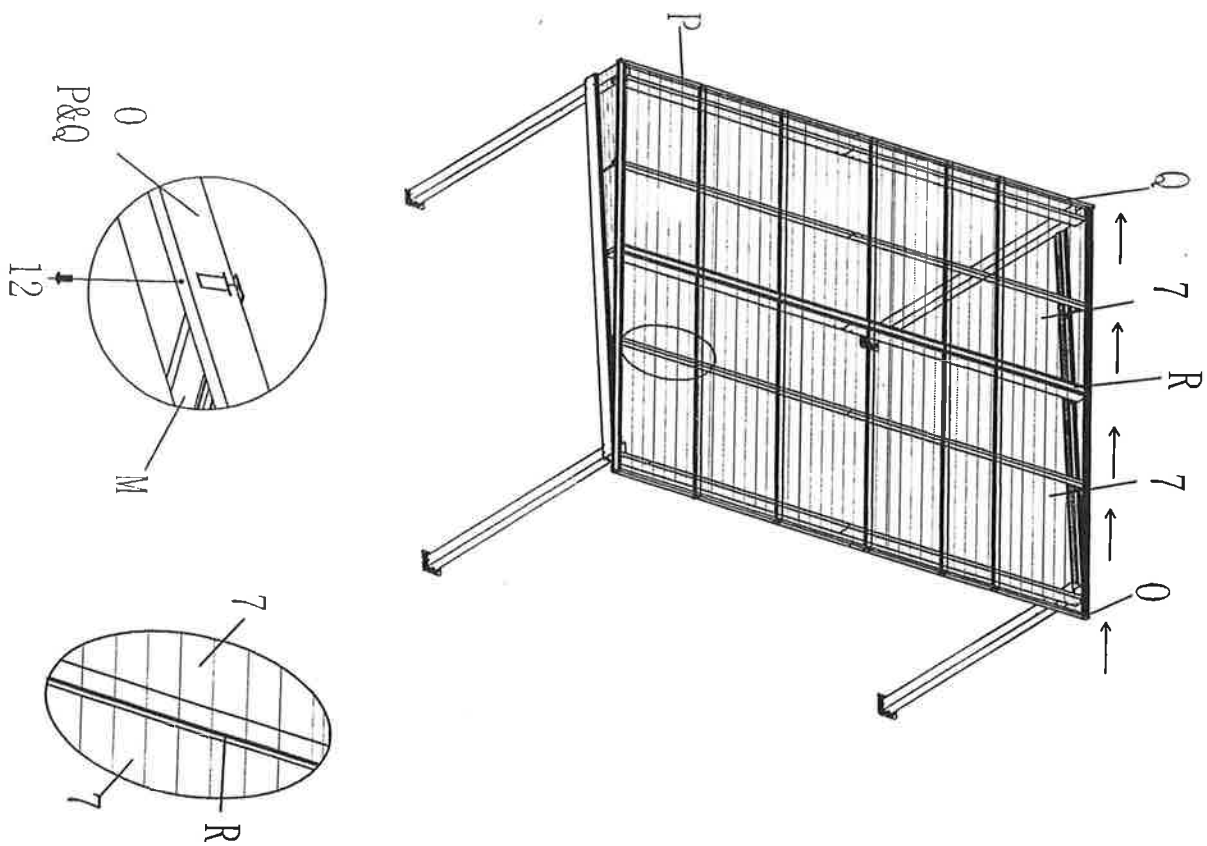

Step:7  
Etape:7

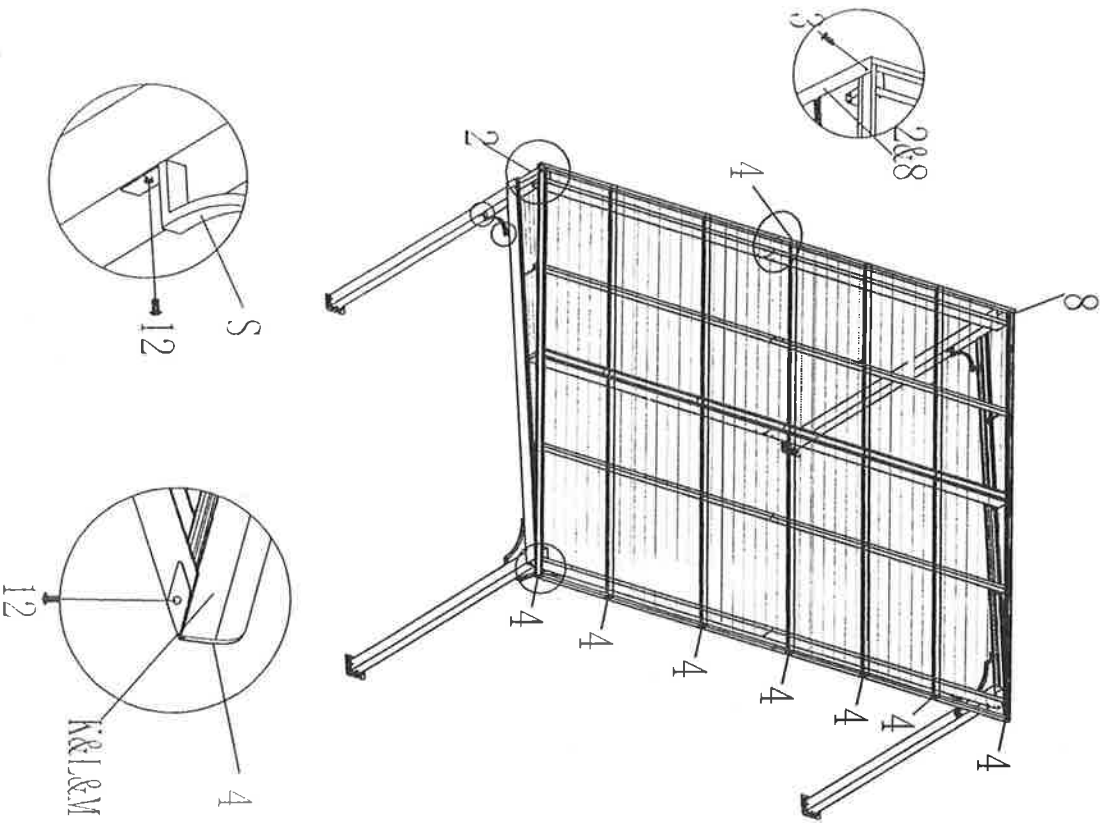

Step:8  
Etape:8

D1 and D2 are strongly recommended to install in winter for supporting roof in case of heavy snow fall.

D1 et D2 sont fortement recommandees d'installer en hiver pour supporter le toit en cas de fortes chutes de neige.

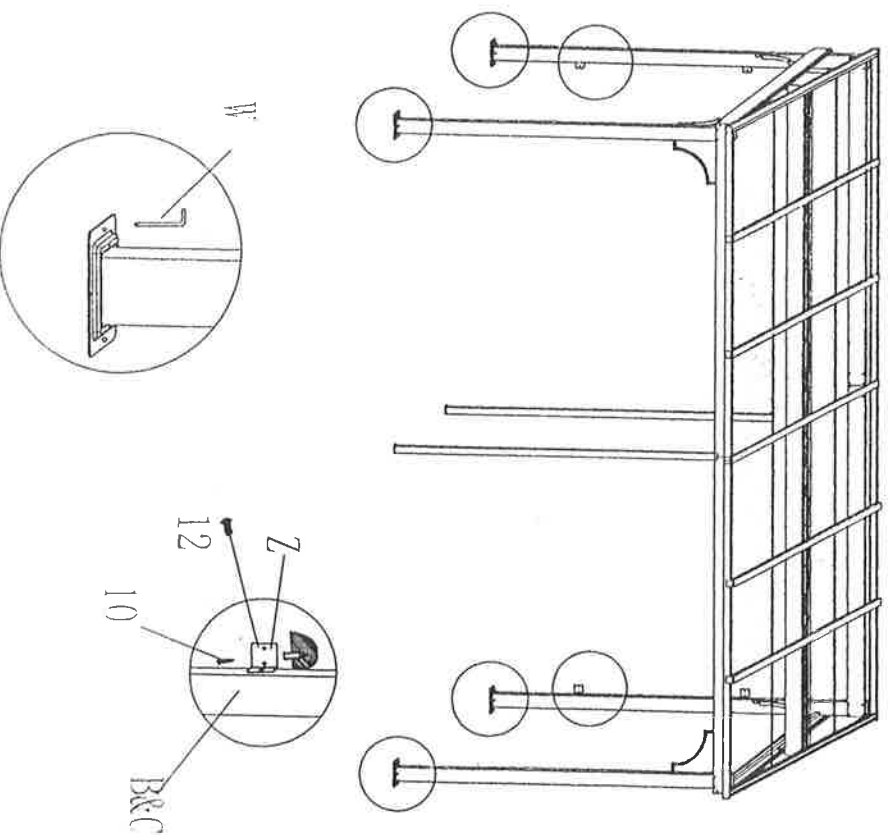

## **new warning label - Verandagazebo.doc**

**Dear customer,**

**Because the proximity of this structure to your house there is always the possibility that a large amount of snow will slide from your home roof to the top of this gazebo, it is therefore highly recommended to remove the polycarbonate panels and the roof cross ribs for the duration of the winter, failure to do so might result in damage to the structure. If you have any question or need more information please contact us.**

**Cher client,**

**Dû à la proximité de cette structure à votre maison, il y a toujours la possibilité qu'une grande quantité de neige glisse de votre toit de maison au toit du gazebo. Il est donc fortement recommandé d'enlever les panneaux en polycarbonate ainsi que les barres transversales de côté pour toute la durée de l'hiver. Ne pas les enlever pourrait entraîner des dommages à la structure. Si vous avez des questions ou besoin de plus d'informations, s'il vous plaît contactez-nous.**